

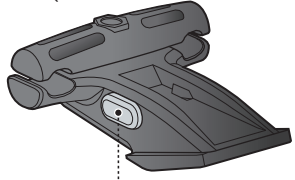

MODE MODUS / MODE / MODO / MODALITA' / TRYB / 機能 / 작동순서 / 模式

DUO FIXER QuickClick®



Release button

Entriegelungsknopf
bouton de déverrouillage
Botón de liberación
Pulsante di rilascio
Przycisk zwalnający
リリースボタン
해제 버튼
快放鈕

Low Battery Power Indicator

Niedrige Akku-Ladestandanzeige
Indicateur de batterie faible
Indicador de batería baja
Indicatore di batteria scarica

Wskaźnik zużycia baterii
容量低下警告
インジケーター
배터리 전원 부족 표시등
弱電顯示

On/off and Mode selection button

An-/Aus- und Modus-Taste
Bouton marche/arrêt
Botón On/Off y Selección de Modo
Corpo in alluminio tasto on/off e modalità selezione
Przycisk włączania i wyboru trybu
電源オン / オフ、モード切り替えスイッチ
켜짐 / 꺼짐 선택 스위치 버튼
開 / 關切換鈕

Charge Indicator

Akku-Ladestandanzeige
indicateur de charge
Indicador de carga
Indicatore di carica
Wskaźnik ładowania
充電 インジケーター
충전 표시등
充電顯示

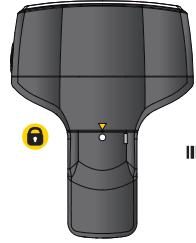
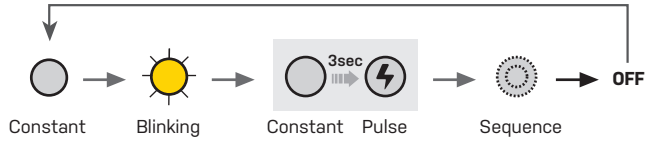

Twist to unlock and release
Zum Entriegeln und Lösen drehen
Faire tourner pour débloquer

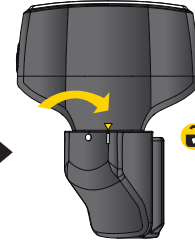

Girar para desbloquear y soltar
Ruotare per sbloccare e rilasciare
Przekręć, aby odblokować i uwolnić

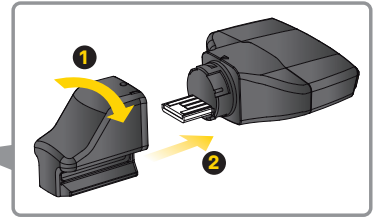

図のように回転させて取り外します
돌려서 잠금 해제 및 잠금 설정
轉向取下防塵蓋

DUO FIXER AND TAILLUX INSTALLATION BEFESTIGUNG VON DUO FIXER & TAILLUX / INSTALLATION DU DUO FIXER ET DU TAILLUX / INSTALACIÓN DE DUO

FIXER Y TAILLUX / MONTAGGIO DUO FIXER E TAILLUX / MONTAŻ DUO FIXER I TAILLUX / デュオフィクサーとテールルクスの取付 / DUO FIXER과 TAILLUX 장착 방법 / DUO FIXER 與尾燈安裝步驟說明

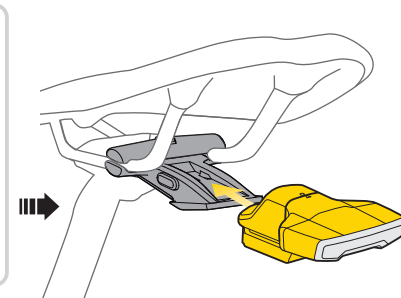
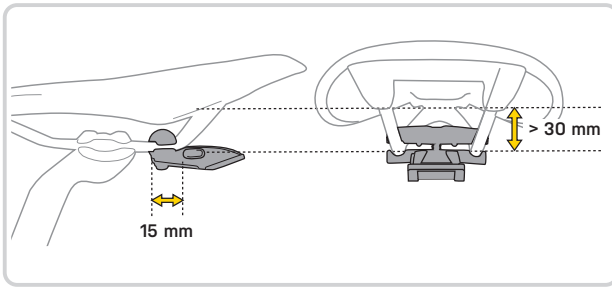
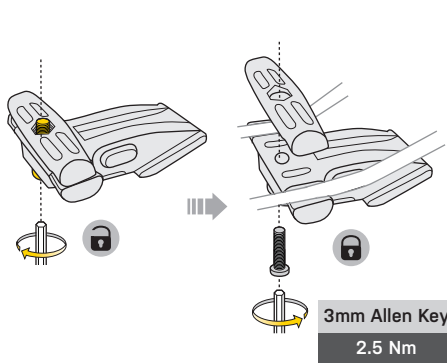

RELEASE

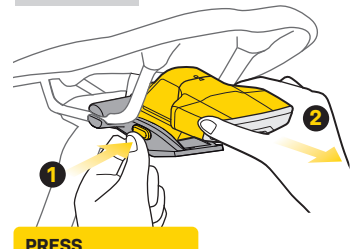

PRESS
DRÜCKEN NACISNIJ
APPLUYER 押す
PRESIONAR 누르기
PREMERE 按壓

SADDLE COMPATIBILITY / SATTELKOMPATIBILITÄT / COMPATIBILITÉ SELLE / COMPATIBILIDAD CON EL SILLÍN / COMPATIBILITÀ SELLA / KOMPATYBILNY Z SIODŁAMI / サドルの互換性 / 안장 호환성 / 座椅適用性

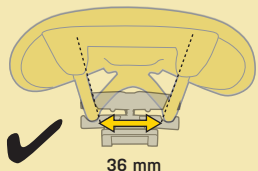

36 mm

Works with

- Standard saddle rail with 36mm spacing
- Carbon, Steel, CrMo, Titanium saddle rails

Kompatibel mit:

- Standard-Sattelgestellen mit 36 mm Abstand
- Sattelgestellen aus Carbon, Stahl, CrMo & Titan

Marche avec

- Rail de selle standard avec espacement de 36 mm
- Rails de selle Carbone, Acier, CrMo, Titane

Válido para

- Rail de sillín estándar con espacio de 36 mm
- Railes de carbono, acero, CrMo, titanio

Compatibile con:

- Carrello sella standard con 36mm di spazio
- Carrelli sella in carbonio, acciaio, CrMo e titanio

Działa z

- Standardowe pręty z rozstawem 36mm
- Pręty karbonowe, stalowe, CrMo, tytanowe

対応サドル

- レール内幅36mm
- カーボン、スチール、クロモリ、チタン製レール

장착 가능

- 36mm 간격 표준 안장 레일
- 카본, 스틸, 크로몰리, 티타늄 안장 레일

可適用

- 標準坐墊，坐弓 間距36mm
- 碳、鋼、鉻鉬鋼、鈦之坐弓

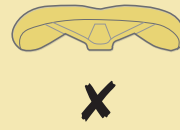

Monorail saddle

Sattel mit Monorail
Selle monorail
Sillín monorail
Sella monobinario
Siodła Monorail
モノレールサドル
모노(단일)레일 안장
單弓坐墊

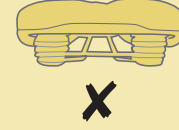

Saddle with rear bumper

Sattel mit Dämpfern
Selle avec amortisseur arrière
Sillín con amortiguación trasera
Sella con paraurti posteriore
Siodła z elastomerem
リアバンパー付サドル
후방 범퍼가 있는 안장
帶後避震的坐墊



Saddle with rear spring

Sattel mit Federn
Selle avec ressort arrière
Sillín con muelle trasero
Sella con molla posteriore
Siodła ze sprężyną
リアスプリング付サドル
후방 스프링 있는 안장
帶後彈簧的坐墊



DUO FIXER MOUNTING SYSTEM

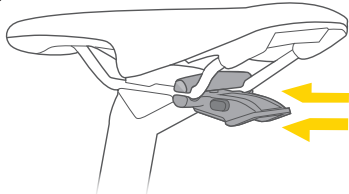

Upper
Lower

DOUBLE USE

with DF series accessories

Zwei Aufnahmen für Zubehör der DF-Serie
Double utilisation avec les accessoires de la série DF
Doble uso con los accesorios de la serie DF
Doppio utilizzo con la serie accessori DF
Podwójne zastosowanie z akcesoriami serii DF
DFシリーズアクセサリを2個取付可能
DF 시리즈 액세서리와 함께 사용가능
與DF系列配件共同使用



SCAN TO DISCOVER MORE ABOUT DF SYSTEM & ACCESSORIES

TUBI TOOL / CO2



TubiMaster GX DF NanoMaster DF

LIGHT

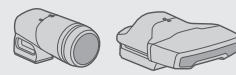

TailLux 40 DF TailLux 25 DF

FENDER



FLASHFENDER DF

1 >>>

2 >>>

STRAP / TIRE LEVER

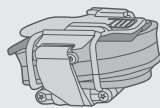

FreePack

FENDER

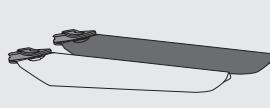

FLASHFENDER DF Deluxe

CO2 / PUMP

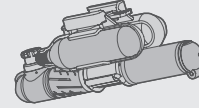

HybridMaster DF

QUICKCLICK SADDLE BAG



Aero Wedge Pack series

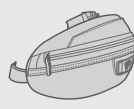

Wedge Pack II Series

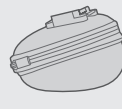

ProPack Series



Wedge DryBag

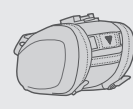

SideKick Wedge Pack Series



MondoPack Series



CABLE-FREE CHARGING / KABELLOSES LADEN / RECHARGE SANS CÂBLE / CARGA SIN

CABLE / RICARICA SENZA CAVO / ŁADOWANIE BEZPRZEWODOWE / 充電方法 / 케이블이 필요없는 USB 충전 단자 / 充電說明



標準充電時間:
2 - 3 小時 (近似值)

USB Insertion Tab
USB-Ladeanschluss
Prise USB
Pestaña de inserción USB
Attacco USB
Wtyczka USB
USB 端子
USB 충전 단자
連接電腦或
USB 電源轉換器

Standard charging time 2 - 3 hours (approx)	Ricarica standard 2 - 3 ore (circa)
Standard Ladezeit 2 - 3 Stunden (ca.)	Średni czas ładowania 2 - 3 godziny (około)
Temps de charge standard +/- 2-3 heures	充電時間 約 2 - 3 時間
Tiempo de carga 2 - 3 h (aprox)	일반적인 충전 시간 2 - 3 시간 (근사치)

SPECIFICATIONS / SPEZIFIKATIONEN / SPÉCIFICATIONS / ESPECIFICACIONES / SPECIFICHE / SPECYFIKACJA / スペック / 제품 사양 / 規格說明

Burn Time : Constant - 10 lm (3.5 hr) Blink - 10 lm (40 hr) Pulse - 25 lm (30 hr) Sequence - 12 lm (20 hr)	Leuchtdauer : Konstant - 3,5 h (10 lm) Blinken - 40 h (10 lm) Pulsierend - 30 h (25 lm) Sequenz - 20 h (12 lm)	Autonomie : Constant - 10 lm (3.5 hr) Clignotant - 10 lm (40 hr) Impulsion - 25 lm (30 hr) Séquence - 12 lm (20 hr)	uración : Constante - 10 lm (3.5 h) Intermittente - 10 lm (40 h) Pulso - 25 lm (30 h) Secuencia - 12 lm (20 h)	Controllo / Durata : Fissa - 10 lm (3.5 ore) Intermittenza - 10 lm (40 ore) Pulsazione - 25 lm (30 ore) Sequenza - 12 lm (20 ore)
Luminous Flux : 25 Lumens (MAX) Input : 5V 500mA Lamp : 8 super bright red LED's Battery : 3.7V 200mAh Lithium Ion (integrated) Charge : USB-A / 2 hr Weight : 30 g	Lichtstrom : max. 25 Lumens Input : 5V 500mA Leuchtmittel : 8 super helle LEDs (rot) Akku : 3,7V 200mAh Lithium-Ionen (integriert) Ladedauer : 2,3 h (USB-A) Gewicht : 30 g	Flux lumineux :: 25 Lumens (MAX) Entrée : 5V 500mA Lampe : 8 LED rouges super brillantes Batterie : 3.7V 200mAh Lithium Ion (intégrée) Charge : USB-A / 2-3 h Poids : 30g	Luminosidad : 25 lúmenes (MAX) Entrada : 5V 500mA Lámpara : 8 LED rojos súper brillantes Batería : iones de litio de 3,7 V y 200 mAh (integrada) Carga : USB-A / 2-3 horas Peso : 30g	Luminosità : 25 Lumens (MAX) Input : 5V 500mA Luce : 8 LED rossi super luminosi Batteria : 3.7V 200mAh ioni di litio (integrata) Ricarica : USB-A / 2-3 ore Peso : 30 g

Czas świecenia : Stały — 10 lm (3,5 h) Miganie — 10 lm (40 h) Pulsacja — 25 lm (30 h) Sekwencja — 12 lm (20 h)	点灯時間 : 点灯 - 10ルーメン (3.5時間) 点滅 - 10ルーメン (40時間) パルス点灯 - 25ルーメン (30時間) パターン点灯 - 12ルーメン (20時間)	사용시간 : 지속 - 10루멘(3.5시간) 점멸 - 10루멘(40시간) 느린 점멸 - 25루멘(30시간) 순차 점멸 - 12루멘(20시간)	使用時間 : 恆亮 10 lm (3.5 hr) 閃爍 10 lm (40 hr) 奏閃 25 lm (30 hr) 連續 12 lm (20 hr)
Strumień świetlny : 25 lumenów (MAX) Wejście : 5V 500mA Lampa : 8 super jasnych czerwonych diod LED Bateria : litowo-jonowa 3,7 V 200 mAh (zintegrowana) Ładowanie : USB-A / 2-3 h Waga : 30g	光束 : 最大25ルーメン 入力 : 5V 500mA LED : 高輝度 レッドLED x 8個 バッテリー : 3.7V 200mAh リチウムイオン内蔵 充電時間 : USB-A / 2~3 時間 重量 : 30 g	밝기 : 25루멘(최대) 입력장치 : 5V 500mA 사이즈 : 6.3 x 2.7 x 2.5cm 배터리 : 3.7V 200mAh 리튬 이온(통합형) 충전방식 및 충전시간 : USB-A 타입 / 2 - 3 시간 중량 : 30 g / 1.06 oz	流明 : 25 Lumens (MAX) 輸入 : 5V 500mA 燈源 : 8顆LED 電池 : 3.7V 200mAh 鋰電池 充電 : USB-A / 2 hr 重量 : 30 g

- The TAILLUX 40 DF **Charge Indicator** will be lit GREEN when charging. LED will turn off when battery is fully charged.
- The TAILLUX 40 DF **Charge Indicator** will be lit RED when the remaining battery power is low. Please charge the light as soon as possible.
- The TAILLUX 40 DF LED will not illuminate if the battery is faulty.
- After TAILLUX 40 DF is fully charged, unplug the USB port.
- Do not open light body.
- Battery may take 3 to 5 charging cycles to attain full capacity.
- Do not leave battery connected to charge source over 48 hours continuously.
- Charging with USB hub will take longer.
- After long periods of non-use, the battery will lose charge. Always charge the battery fully before each use and storage.
- Maintain the battery by charging it every two months and storing it in a cool, dry place to prevent from decreasing its lifespan.
- Safely and properly dispose of the light body according to your local regulations.
- Please use the charger as the specification shown on the user's guide. Do not use quick charger, otherwise it might cause damage.

- L'indicatore di carica di TAILLUX 40 DF sarà VERDE durante la carica. Il LED si spegnerà quando la batteria sarà completamente carica.
- L'indicatore di carica di TAILLUX 40 DF sarà ROSSO quando il livello di batteria residua è basso. Si prega di ricaricare la luce il prima possibile.
- Il LED di TAILLUX 40 DF non si accenderà se la batteria è guasta.
- Quando la ricarica di TAILLUX 40 DF è completa, staccare il cavo USB dalla porta.
- Non aprire il corpo della luce.
- La batteria potrebbe impiegare dai 3 ai 5 cicli di ricarica per raggiungere la massima autonomia.
- Non lasciare la batteria connessa alla sorgente di ricarica per più di 48 ore consecutive.
- Il tempo di ricarica via hub USB è più lungo.
- Dopo lunghi periodi di inutilizzo, la batteria inizierà a perdere autonomia. Ricaricare sempre la batteria completamente prima di ogni uso e prima di riparla.
- Preservare la batteria caricandola almeno ogni due mesi e riponendola in un luogo fresco e asciutto per prevenire la riduzione del suo ciclo di vita.
- Smaltire in sicurezza e in modo appropriato il corpo della luce in accordo con le tue leggi locali.
- Si prega di utilizzare il caricatore come specificato nella guida utente. Non utilizzare caricatori rapidi, potrebbero causare danni.

WARRANTY 1-year Warranty against manufacturer defects only. (Batteries are not covered under any implied warranty.) Warranty Claim Requirements To obtain warranty service, you must be the original owner and provide proof of purchase. Items returned without a sales receipt will assume that the warranty begins on the date of manufacture. All warranties will be void if the product is damaged due to user crash, abuse, system alteration, modification, or used in any way not intended as described in this manual. * The specifications and design are subject to change without notice. Please contact your Topeak dealer with any questions. For USA customer service, call: 1-800-250-3068 www.topeak.com	GEWÄHRLEISTUNG Gewährleistungsanspruch Sie benötigen Ihren Originalkaufbeleg um den Gewährleistungs-Service zu erhalten. Bei Artikel die ohne Kaufbeleg eingesendet werden, wird davon ausgegangen, dass die Gewährleistung mit dem Herstellungsdatum beginnt. Alle Gewährleistungsansprüche werden ungültig, wenn der Artikel auf Grund eines Unfalls beschädigt oder zweckentfremdet wurde, Systemänderungen oder andere Veränderungen vorgenommen wurden oder der Artikel anderweitig verwendet wurde als in diesem Handbuch beschrieben. * Änderungen in Design und Eigenschaft bedürfen keiner vorherigen Ankündigung. Topeak Produkte sind ausschließlich im Fahrradfachhandel erhältlich. Bitte nehmen Sie Kontakt mit Ihrem nächsten Topeak Händler auf, um offene Fragen zu klären. Für Kunden in Deutschland, Tel. 0261-899998-28/ Homepage: www.topeak.com	GARANTIE Garantie de 1 an toutes parties mécaniques contre tout défaut de fabrication. (Les batteries ne sont pas couvertes par la garantie.) Reclamation de la garantie Pour bénéficier de notre service de garantie, vous devez être en possession de la facture d'achat originale. Si le produit nous est retourné sans cette facture d'achat, nous considérons la date de fabrication comme début de la garantie. Toute garantie sera considérée comme nulle si le produit à été endommagé suite à une chute, à un abus, une surcharge, à un quelconque changement ou modification ou à une utilisation autre que celle décrite dans ce manuel. * Les spécifications et l'apparence peuvent être sujettes à certaines modifications. Contactez votre revendeur Topeak si vous avez la moindre question. For USA customer service, call : 1-800-250-3068 www.topeak.com	GARANTÍA Garantía de 1 año únicamente para productos con defectos de fabricación. (Las baterías no están cubiertas por ninguna garantía implícita.) Requisitos para la reclamación de garantía Para obtener el servicio de garantía, debe ser el propietario original y proporcionar un comprobante de compra. Los artículos devueltos sin un recibo de compra comenzarán la garantía en la fecha de fabricación. Todas las garantías quedarán anuladas si el producto se daña debido a un accidente del usuario, abuso, alteración del sistema, modificación o uso de cualquier forma diferente a la descrita en este manual. * Las especificaciones y el diseño están sujetos a cambios sin previo aviso. Póngase en contacto con su distribuidor Topeak si tiene alguna pregunta. Para llamar al servicio de atención al cliente de EE. UU.: 1-800-250-3068 www.topeak.com	GARANZIA 1 anno di garanzia solo per difetti di produzione. (Le batterie non sono coperte da garanzia.) Condizioni di garanzia Per usufruire della garanzia è necessario essere il primo proprietario dell'articolo e fornire lo scontrino originale di acquisto. In caso il prodotto ci venga restituito senza lo scontrino la garanzia decorrerà dalla data di fabbricazione. La garanzia decade qualora il prodotto venga danneggiato da uso improprio, sovraccarico, modifiche o utilizzato in maniera diversa da quella descritta in questo manuale. * Le caratteristiche del prodotto possono essere cambiate senza preavviso. I prodotti Topeak sono in vendita nei negozi specializzati per ciclisti. Per ogni richiesta o chiarimento rivolgetevi al rivenditore Topeak più vicino. Sito web: www.topeak.com
---------------------------------------------------------------------------------------------------------------------------------------------------------------------------------------------------------------------------------------------------------------------------------------------------------------------------------------------------------------------------------------------------------------------------------------------------------------------------------------------------------------------------------------------------------------------------------------------------------------------------------------------------------------------------------------------------------------------------------------------------------------	-----------------------------------------------------------------------------------------------------------------------------------------------------------------------------------------------------------------------------------------------------------------------------------------------------------------------------------------------------------------------------------------------------------------------------------------------------------------------------------------------------------------------------------------------------------------------------------------------------------------------------------------------------------------------------------------------------------------------------------------------------------------------------------------------------------------------------------------------------------------------------------------------------------	----------------------------------------------------------------------------------------------------------------------------------------------------------------------------------------------------------------------------------------------------------------------------------------------------------------------------------------------------------------------------------------------------------------------------------------------------------------------------------------------------------------------------------------------------------------------------------------------------------------------------------------------------------------------------------------------------------------------------------------------------------------------------------------------------------------------------------------------------------------------------------------------------------------	-------------------------------------------------------------------------------------------------------------------------------------------------------------------------------------------------------------------------------------------------------------------------------------------------------------------------------------------------------------------------------------------------------------------------------------------------------------------------------------------------------------------------------------------------------------------------------------------------------------------------------------------------------------------------------------------------------------------------------------------------------------------------------------------------------------------------------------------------------------------------------------------------------------------	-----------------------------------------------------------------------------------------------------------------------------------------------------------------------------------------------------------------------------------------------------------------------------------------------------------------------------------------------------------------------------------------------------------------------------------------------------------------------------------------------------------------------------------------------------------------------------------------------------------------------------------------------------------------------------------------------------------------------------------------------------------------------------------------------------------------------------------------------------------

GAWARANCJA 1rok gwarancji: Na wady fabryczne. (Baterie nie są objęte żadną dorozumianą gwarancją.) Warunki korzystania z gwarancji Aby uzyskać serwis gwarancyjny, należy być pierwszym właścicielem i posiadać dowód zakupu. Gdy produkt reklamowany jest bez paragonu zakładamy, że gwarancja rozpoczyna się od daty produkcji. Wszystkie gwarancje są nieważne jeśli produkt został uszkodzony na skutek wypadku, nadużycia, zmiany, modyfikacji lub wykorzystywany w jakikolwiek sposób niezgodny z opisanym w niniejszej instrukcji. * Specyfikacja i projekt mogą ulec zmianie bez powiadomienia. W przypadku jakichkolwiek pytań skontaktuj się ze sprzedawcą lub importерem Topeak.	保証期間 ご購入日より1年間: 製造上の欠陥による機械部品の不良が対象です。(バッテリーは保証の対象になりません) 保証の請求 保証を受けるには、ご購入の日付のった領収書が必要です。領収書なしで保証を受ける場合の保証期間は製造年月日から起算させていただきます。お客様の事故などによる外的要因、誤使用、改造、およびこの取扱説明書に従わない本来の用途以外のご使用による故障は保証を受けられません。故障した製品は故障状況を明記して、お買い上げの販売店へお持ちください。お送りになる場合の送料はお客様にご負担をお願いします。 *スペックやデザインは改良のため予告なく変更されることがあります。 ご質問は、最寄りのトピーク正規販売店へどうぞ。 Website: www.topeak.jp	품질보증 제한된 1년 품질 보증 / 소비자 과실을 제외한 제조과정상 결함에 대하여 1년간 보증합니다. (배터리 보증 제외) 품질 보증을 위한 필요조건 품질 보증 서비스를 받으려면, 반드시 원본 구매 영수증을 제시해야 합니다. 구매 영수증이 없는 경우, 모든 제품은 그 제품의 가장 최초 제조일로부터 3개월 후를 구입일로 인정합니다. 외부 손상, 사용자의 오용, 남용, 임의 개조, 변경 또는 사용설명서에 기술한 내용에 맞지 않게 사용된 경우 품질 보증을 받을 수 없습니다. * 제품의 제원이나 디자인은 사전공지 없이 변경될 수 있습니다. 국내 전문 대리점을 통해 구입 가능합니다. 홈페이지 : www.hlsc.co.kr , www.topeak.com	產品保固 保固要求 申請保固期限中的服務, 須檢具購買時之發票, 若無法提供, 則其保固期限將自製造日期開始算起。若因使用者不慎摔壞、使用不當、自行改裝、更改系統或未能按照說明書上的正確操作方式, 本產品將不被列入保固範圍。 * 本公司保留產品規格變更之權利。 Topeak 產品相關的資訊, 請洽詢 Topeak 當地授權的經銷商 網址: www.topeak.com
---------------------------------------------------------------------------------------------------------------------------------------------------------------------------------------------------------------------------------------------------------------------------------------------------------------------------------------------------------------------------------------------------------------------------------------------------------------------------------------------------------------------------------------------------------------------------------------------------------------------------------------------------------------------------------------------------------------------------------	-------------------------------------------------------------------------------------------------------------------------------------------------------------------------------------------------------------------------------------------------------------------------------------------------------------------------------------------------------------------------------------	-------------------------------------------------------------------------------------------------------------------------------------------------------------------------------------------------------------------------------------------------------------------------------------------------------------------------------------------------------------------------------------------------------------	------------------------------------------------------------------------------------------------------------------------------------------------------------------------------------------------------------------------